THE SPARK SERIES

VIDERI DIGITAL CANVAS
SPECIFICATIONS

BE SEEN.

Spark Series

Videri brings the easy to digital.

For new spaces and unusual places, the Spark Series Digital Canvas fits where other displays do not. The Spark Series is Videri's 4th generation Canvas with 5 unique sizes - our most innovative line yet. Enhanced clarity and vibrancy are supported by upgraded screen haze and reduced glare. Our LCD display panel technology provides the best color and viewing angles. WiFi6 and Bluetooth 5.2 enable faster, more stable connectivity, while best in class processing capabilities with 4K UHD means content is rendered smoothly and apps are launched effortlessly.

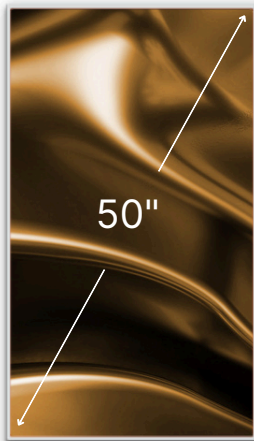

Spark5

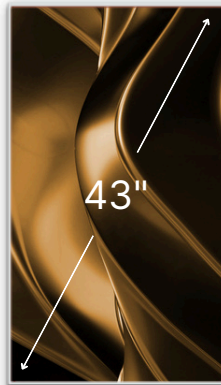

Spark4



Spark3

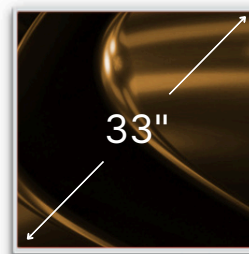

SparkQ+



Spark2

- Stunningly thin with a uniform Canvas depth of 15.5mm
- Low-power, sustainable
- Integrated commercial grade media player (Android™) for content, apps and services
- Commercial grade 24/7
- Fully wireless, no HDMI, USB or Ethernet port
- Tamper proof, encrypted

Single or several. Maximum Impact.

A single Canvas across multiple locations.

- Simple to install. Effortless to manage
- Drive 30% average increase in sales
- Fits in with no retrofits
- Imagination is your only limitation

Multiple Canvases used together in a Wall.

- Orchestrate content wirelessly
- No splitters or custom content
- Content automatically adjusts for gaps
- Use Canvases individually & combined in the same schedule



Spark5

The largest of the Spark Series at 50 inches, with 4K UHD, the Spark5 makes a stand-out statement for any digital content.

DISPLAY

Screen Size	50"
Resolution	3840 x 2160 4K UHD
Brightness	450 nits
Dark Mode	0.56 nits
Surface Treatment	25% Haze
Color Gamut	72% NTSC
Dimming Type	Remote only
Operation Time	24/7
Portrait/Tilt Compatibility	Yes

TECHNOLOGY

Processor	RK3588
Wi-Fi	WiFi6
Bluetooth	5.2
Operating System	Android 12
Onboard Storage	25GB

POWER

Input	100-240V~50/60Hz
Consumption (Typ)	81W
Dynamic Backlight Control	Yes

ENVIRONMENT

Operating Temp.	Min: 0C, Max: +50C
Operating Humidity	10% RH - 80% RH

CERTIFICATION & COMPLIANCE

Safety	UL, CSA, CE
--------	-------------

SIZING

Bezel Width	.53" (13.5mm)
Canvas Depth	.61" (15.5mm)
Weight	28.7lbs (13kg)
Package Weight	38.6lbs (17.5kg)
Package Dimensions	47x30x4" (1195x765x105mm)
W x H x D	

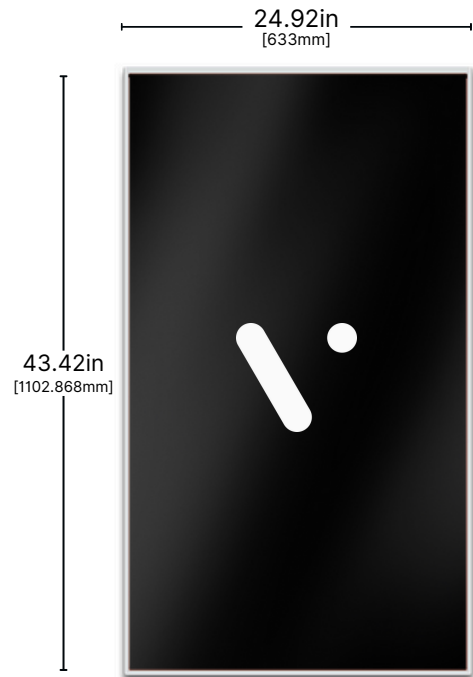

BACK

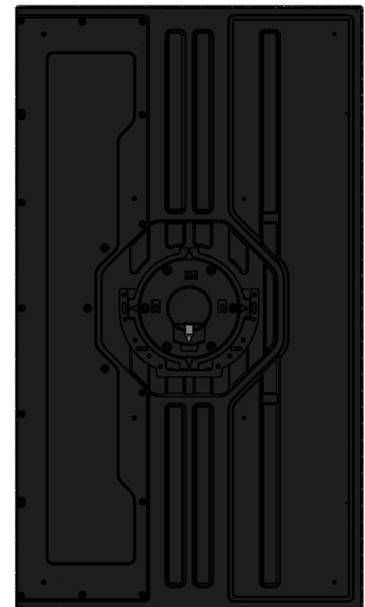

Spark4

At an impressive 43 inches and with 4K UHD, the Spark4 is a universal size large enough to be high impact on its own, yet fits into most placements.

DISPLAY

Screen Size	43"
Resolution	3840 x 2160 4K UHD
Brightness	450 nits
Dark Mode	0.56 nits
Surface Treatment	25% Haze
Color Gamut	72% NTSC
Dimming Type	Remote only
Operation Time	24/7
Portrait/Tilt Compatibility	Yes

TECHNOLOGY

Processor	RK3588
Wi-Fi	WiFi6
Bluetooth	5.2
Operating System	Android 12
Onboard Storage	25GB

POWER

Input	100-240V~50/60Hz
Consumption (Typ)	63W
Dynamic Backlight Control	Yes

ENVIRONMENT

Operating Temp.	Min: 0C, Max: +50C
Operating Humidity	10% RH - 80% RH

CERTIFICATION & COMPLIANCE

Safety	UL, CSA, CE
--------	-------------

SIZING

Bezel Width	.53" (13.5mm)
Canvas Depth	.61" (15.5mm)
Weight	20.94lbs (9.5kg)
Package Weight	31.9lbs (14.45kg)
Package Dimensions	41.5x27x4" (1057x690x105mm)
W x H x D	

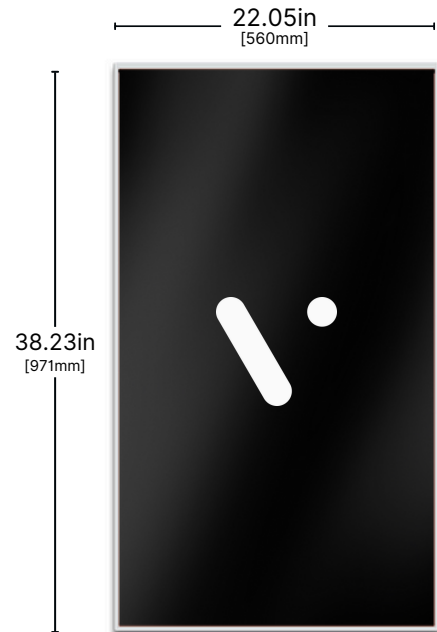

BACK

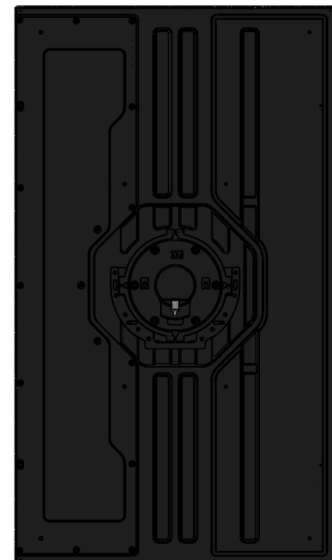

SparkQ+

A perfect square to add dimension and uniqueness to your layout. The SparkQ+, at 33 inches, gives you digital flexibility and adds originality to any placement.

DISPLAY

Screen Size	33"
Resolution	1920 x 1920
Brightness	450 nits
Dark Mode	0.56 nits
Surface Treatment	25% Haze
Color Gamut	72% NTSC
Dimming Type	Remote only
Operation Time	24/7
Portrait/Tilt Compatibility	Yes

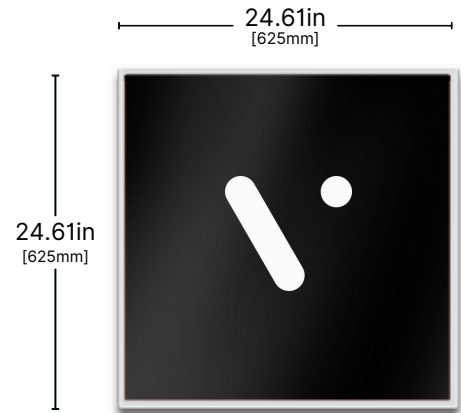

TECHNOLOGY

Processor	RK3588
Wi-Fi	WiFi6
Bluetooth	5.2
Operating System	Android 12
Onboard Storage	25GB

POWER

Input	100-240V~50/60Hz
Consumption (Typ)	53W
Dynamic Backlight Control	Yes

ENVIRONMENT

Operating Temp.	Min: 0C, Max: +50C
Operating Humidity	10% RH - 80% RH

CERTIFICATION & COMPLIANCE

Safety	UL, CSA, CE
--------	-------------

SIZING

Bezel Width	.53" (13.5mm)
Canvas Depth	.61" (15.5mm)
Weight	15.4lbs (7kg)
Package Weight	17.9lbs (8.1kg)
Package Dimensions	29x28x4" (750x710x100mm)
W x H x D	

BACK

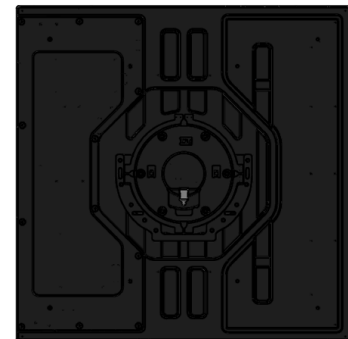

Spark3

The workhorse of any brand's digital footprint, the Spark3 is ideal for smaller placements and is perfectly embedded into retail fixtures.

DISPLAY

Screen Size	32"
Resolution	1920 x 1080 FHD
Brightness	450 nits
Dark Mode	0.56 nits
Surface Treatment	25% Haze
Color Gamut	72% NTSC
Dimming Type	Remote only
Operation Time	24/7
Portrait/Tilt Compatibility	Yes

TECHNOLOGY

Processor	RK3588
Wi-Fi	WiFi6
Bluetooth	5.2
Operating System	Android 12
Onboard Storage	25GB

POWER

Input	100-240V~50/60Hz
Consumption (Typ)	36W
Dynamic Backlight Control	Yes

ENVIRONMENT

Operating Temp.	Min: 0C, Max: +50C
Operating Humidity	10% RH - 80% RH

CERTIFICATION & COMPLIANCE

Safety	UL, CSA, CE
--------	-------------

SIZING

Bezel Width	.53" (13.5mm)
Canvas Depth	.61" (15.5mm)
Weight	12.1lbs (5.5kg)
Package Weight	15.8lbs (7.15kg)
Package Dimensions W x H x D	32x21.25x4" (815x540x100mm)

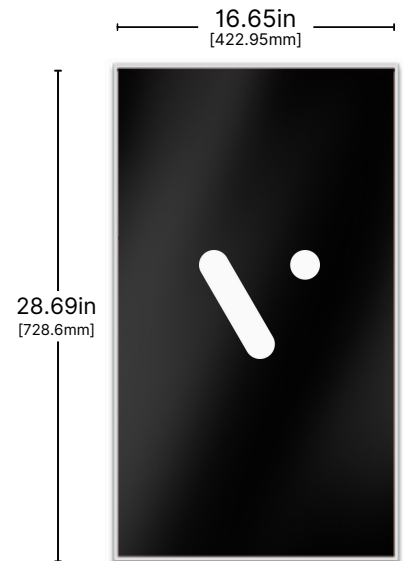

BACK

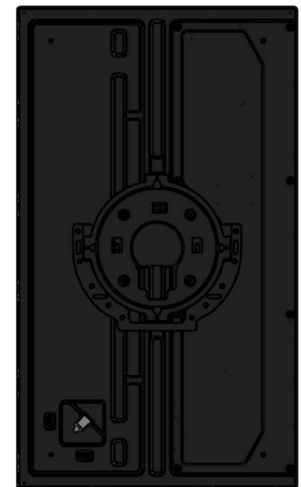

Spark2

The Spark2 is our smallest, most versatile Canvas. Available in both a standard version and with 4G LTE* connectivity, for ideal placement at point of sale, on end-caps and in locations where WiFi is unavailable/unreliable.

DISPLAY

Screen Size	18.5"
Resolution	1920 x 1080 FHD
Brightness	450 nits
Dark Mode	0.56 nits
Surface Treatment	25% Haze
Color Gamut	72% NTSC
Dimming Type	Remote only
Operation Time	24/7
Portrait/Tilt Compatibility	Yes

TECHNOLOGY

Processor	RK3588
Wi-Fi	WiFi6
Bluetooth	5.2
Operating System	Android 12
Onboard Storage	25GB
Network	*Optional 4G LTE

POWER

Input	100-240V~50/60Hz
Consumption (Typ)	17W
Dynamic Backlight Control	Yes

ENVIRONMENT

Operating Temp.	Min: 0C, Max: +50C
Operating Humidity	10% RH - 80% RH

CERTIFICATION & COMPLIANCE

Safety	UL, CSA, CE
--------	-------------

SIZING

Bezel Width	.53" (13.5mm)
Canvas Depth	.61" (15.5mm)
Weight	5.0lbs (2.25kg)
Package Weight	6.22lbs (2.82kg)
Package Dimensions	21x16x4" (530x400x100mm)
W x H x D	

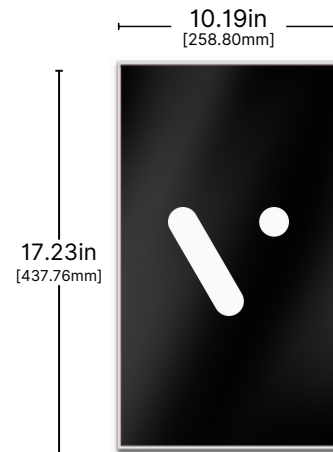

BACK

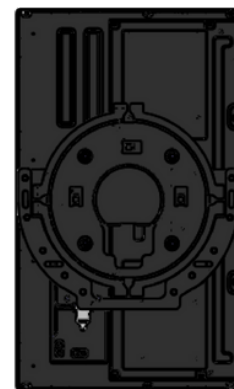

SOFTWARE

Single, user-centered, cloud-connected console.

Content & device management across 1 or 100,000 displays.

- Effortlessly deploy, manage and monitor remotely with our intuitive platform
- Scale with confidence, from compact to colossal, straightforward to sophisticated
- Smart features that deliver a wealth of insights and fluid control
- Open architecture designed for seamless integration with your favorite tools, software & devices
- Comprehensive security, safeguarding every link in the chain

ACCESSORIES

Includes Videri Standard Mount

Thickness: 0.20in [5mm]

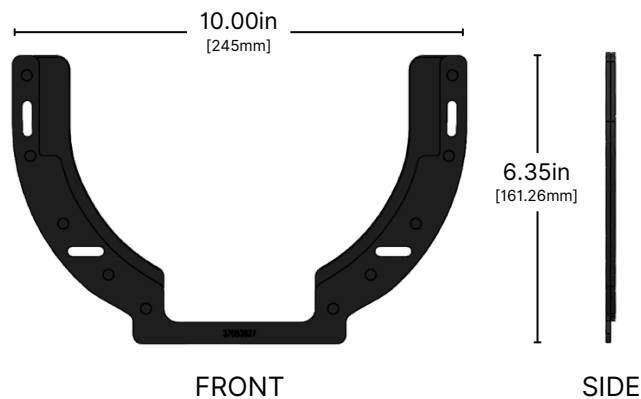

Power Adaptor

Length: 138.3 +/- 0.01 +/- 1.5mm

Width: 68.8 +/- 0.01 +/- 1.5mm

Height: 26 +/- 0.01 +/- 1.5mm

Power Cord

Length: 1500 +/- 50mm

16 AWG

Supported VESA Mount Specifications

Spark5	Spark4	SparkQ+	Spark3	Spark2
400 x 200mm	400 x 200mm	400 x 200mm	100 x 100mm	100 x 100mm

CAD FILES

Available upon request.

To learn more, contact a Videri sales representative at info@videri.com or visit videri.com.

Founded in 2013, Videri is an end-to-end digital display platform that enables marketers and businesses everywhere to create impactful experiences at the point of decision. With more than 100,000 Videri Digital Canvases deployed across more than 80 countries, Videri powers the digital content of some of the world's largest global brands at scale.

Videri is a registered trademark of Videri Inc.

